

**Franklin®**



68in x 48in (1.73m x 1.22m)

# FLYBACK® LG RETURN

ITEM NUMBER: **19037**



Made In China  
Franklin Sports Inc.  
Stoughton, MA 02072

**Franklin®**

Major League Baseball trademarks and copyrights  
are used with permission of Major League Baseball.  
Visit [MLB.com](http://MLB.com)

**NOTE: PRINT FRONT TO BACK, BOOKLET STYLE**

# Franklin®

## CUSTOMER SERVICE COMMITMENT

Thank you for purchasing this Franklin® product! In the event that the product you've purchased has missing or damaged parts, please contact us at:

[parts@franklinsports.com](mailto:parts@franklinsports.com)

or

Visit our website at: [franklinsports.com/instructions](http://franklinsports.com/instructions)

If possible, please include product part number and parts description so we can best assist you.

## WE'RE HERE FOR YOU!

**PLEASE DO NOT RETURN THIS PRODUCT TO THE STORE IT WAS PURCHASED FROM.**

**WE ARE COMMITTED TO FULFILLING ALL REPLACEMENT PART NEEDS IMMEDIATELY.**

Thank you for your continued support, and welcome to the #FranklinFamily!

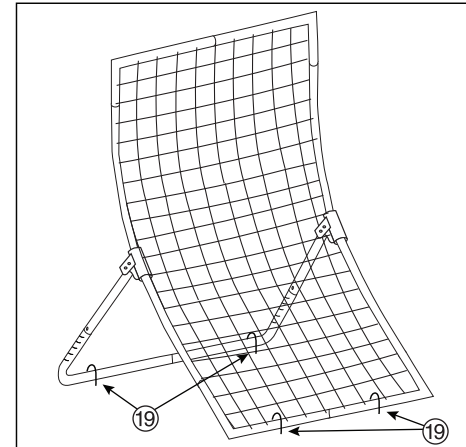
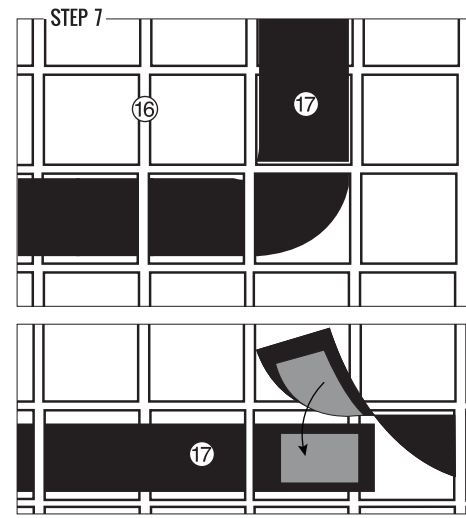

### PARTS

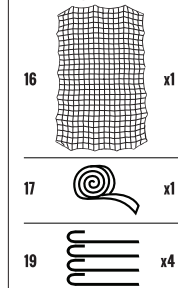

### NOTE

Attach the **Strike Zone Ribbon** (#17) by weaving through the **Net** (#16) and connecting the self stick patches at the end.

NOTE: use **Ground Stakes** (#19) for extra stability when needed.



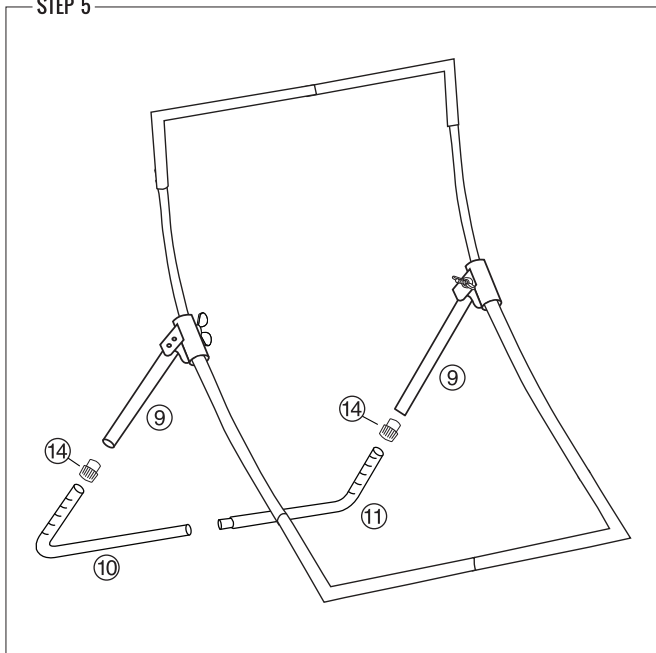

**⚠ WARNING:**  
Use extreme caution when assembling the net to the frame. The bungees will be under extreme tension and must be attached carefully. Adult assembly is strongly recommended.

## YOU ARE NOW READY TO PLAY!

STEP 5



PARTS

- 9  x2
- 10  x1
- 11  x1
- 14  x2



NOTE

Take **Height Adjusters** (#14) and slide onto both **Back Middle Tubes** (#9). Then, take **Left Back Corner Tube** (#10), slide into **Height Adjuster** (#14) and tighten. Repeat on other side for **Right Back Corner Tube** (#11). After, connect **Left & Right Back Corner Tubes** (#10 and #11) at the bottom.

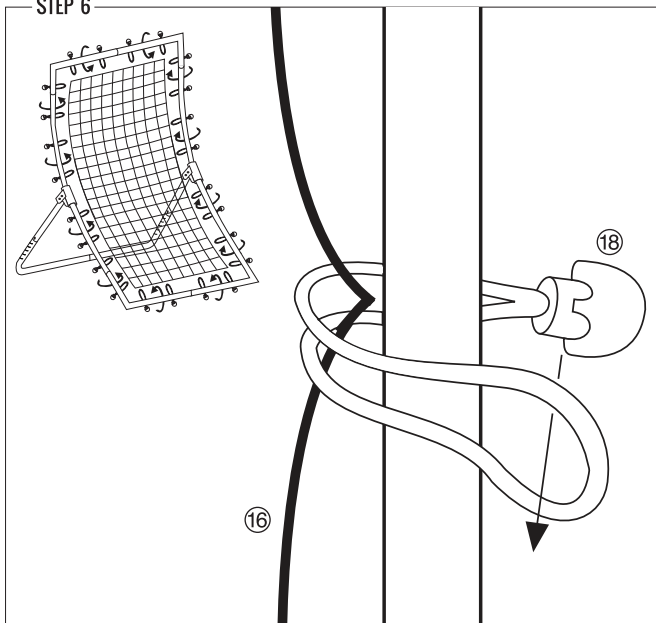
STEP 6



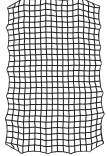







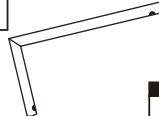
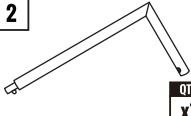
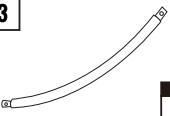

PARTS

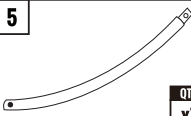
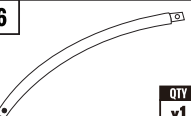
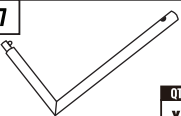
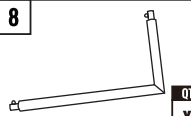
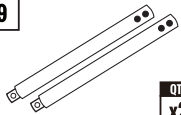
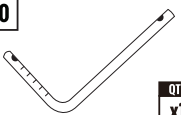
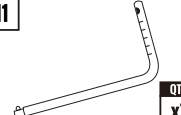
- 16  x1
- 18  x24

NOTE

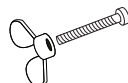
To attach **Net** (#16) to frame, spread out net and find red tabs attached to net. The red tabs indicate the corners. To attach **Toothed Bungees** (#18) to net hold plastic ball in place and wrap free end around net and side tube. Loop the free bungee around the plastic ball.

PARTS LIST

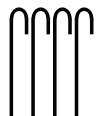
1  QTY x1	2  QTY x1	3  QTY x1	4  QTY x1
Left Top Corner Tube Rep Part: 19037-R1	Right Top Corner Tube Rep Part: 19037-R2	Left Top Middle Tube Rep Part: 19037-R3	Right Top Middle Tube Rep Part: 19037-R19
5  QTY x1	6  QTY x1	7  QTY x1	8  QTY x1
Left Bottom Middle Tube Rep Part: 19037-R4	Right Bottom Middle Tube Rep Part: 19037-R5	Left Bottom Corner Tube Rep Part: 19037-R6	Right Bottom Corner Tube Rep Part: 19037-R7
9  QTY x2	10  QTY x1	11  QTY x1	12  QTY x1
Back Middle Tubes Rep Part: 19037-R8	Left Back Corner Tube Rep Part: 19037-R9	Right Back Corner Tube Rep Part: 19037-R10	Left Hinge Rep Part: 19037-R11
13  QTY x1	14  QTY x2	15  QTY x2	16  QTY x1
Right Hinge Rep Part: 19037-R12	Height Adjusters Rep Part: 19037-R13	Bolt & Wing Nut Set Rep Part: 24804-R14	Net Rep Part: 19037-R15
17  QTY x1	18  QTY x24	19  QTY x4	
Strike Zone Ribbon Rep Part: 24804-R16	Toothed Bungees Rep Part: 24804-R23	Ground Stakes Rep Part: 24804-R18	

ASSEMBLY INSTRUCTIONS

GENERAL NOTE



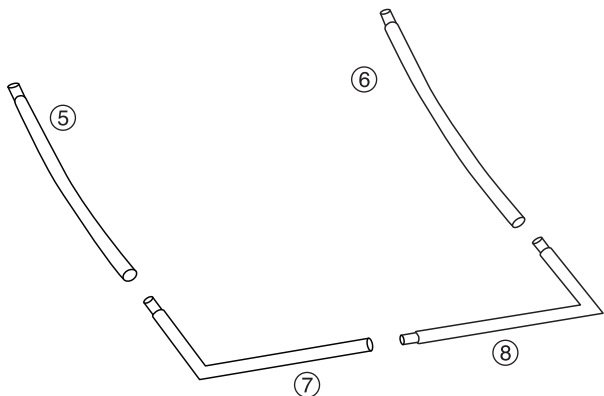

1. Find a clean, level place to begin the assembly of your FLYBACK® LG Return. We recommend that two adults work together to assemble this FLYBACK® LG Return.

2. Remove all components from the package and confirm all the parts are included. Please see Step 1 to begin assembly.

STEP 1

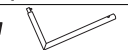

PARTS

- 5  x1
- 6  x1
- 7  x1
- 8  x1



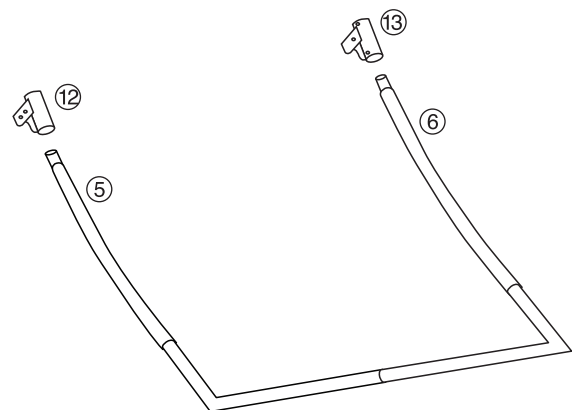

NOTE

Take **Left Bottom Corner Tube & Right Bottom Corner Tube** (#7 & #8) and connect with push buttons to begin to form bottom of frame. Then, take **Left Bottom Middle Tube & Right Bottom Middle Tube** (#5 & #6) and connect to **Left Bottom Corner Tube & Right Bottom Corner Tube** (#7 & #8) respectively.

STEP 2



PARTS

- 5  x1
- 6  x1
- 12  x1
- 13  x1





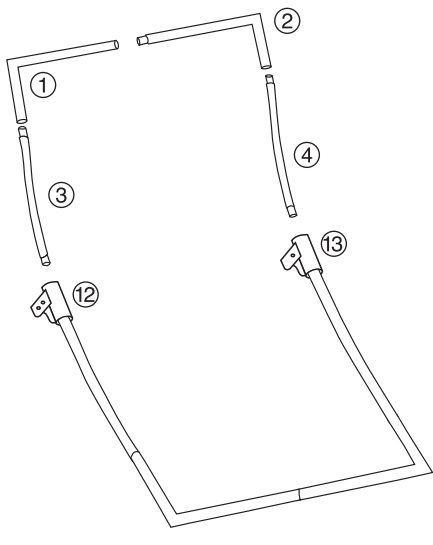

NOTE

Take **Left Hinge** (#12) and connect to **Left Bottom Middle Tube** (#5) with push button. Repeat on other side using **Right Hinge** (#13) and connect to **Right Bottom Middle Tube** (#6).

STEP 3



PARTS

- 1  x1
- 2  x1
- 3  x1
- 4  x1
- 12  x1
- 13  x1



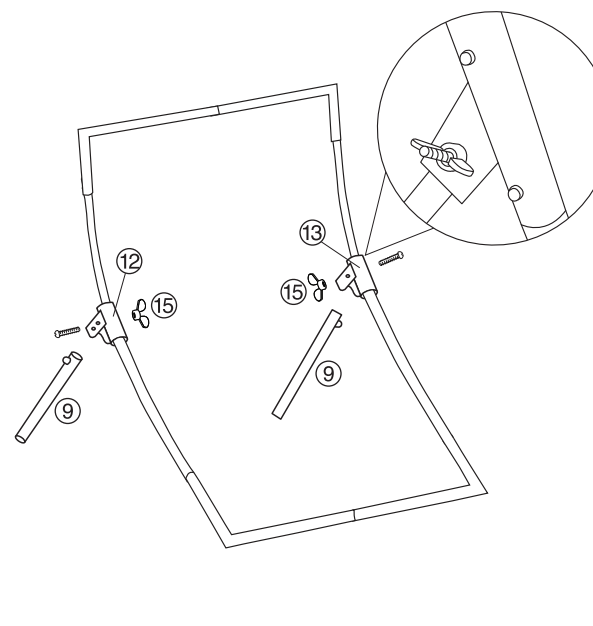

NOTE

Take **Left Top Middle Tube & Right Top Middle Tube** (#3 & #4) and attach with push buttons to **Left Hinge & Right Hinge** (#12 & #13). Then, take **Left Top Corner Tube & Right Top Corner Tube** (#1 & #2) and attach to **Left Top Middle Tube & Right Top Middle Tube** (#3 & #4) on each side. After, connect **Left Top Corner Tube & Right Top Corner Tube** (#1 & #2) at the top to complete frame.

STEP 4



PARTS

- 9  x2
- 12  x1
- 13  x1
- 15  x2

NOTE

To create collapsibility feature begin with **Back Middle Tubes** (#9). Use push button and connect to outside bottom hole on **Left Hinge** (#12). Then, use **Bolt & Wing Nut Set** (#15) and slide screw through **Hinge** (#12) and **Back Middle Tube** (#9) top hole and attach wing nut on other side. Repeat for other side with **Right Hinge** (#13).