

NOTE

To secure the top of the Net (#4), connect the red loop at the top corners of the net to the top of each Fiberglass Pole (#2).

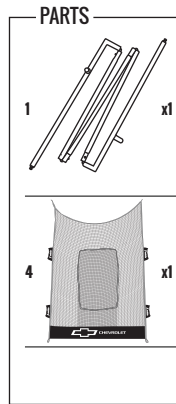
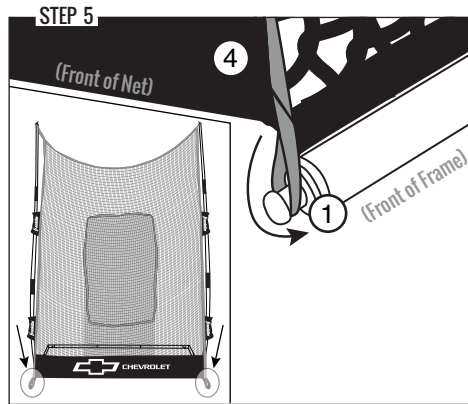

NOTE

To secure the bottom of the net, connect the black loop at the front corners of the net to the front poles of the Steel Frame (#1) as shown.

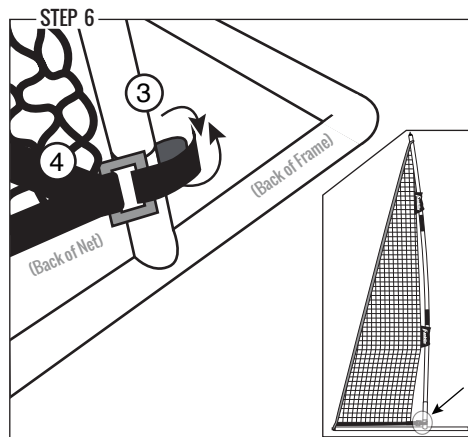

NOTE

Connect the self stick straps at the back corners of the net to each Vertical Steel Support (3) as shown.

NOTE:
Use Ground Stakes (#6) for extra stability.

NOTE:
Black Travel Bag (#5) included for easy portability.

YOU ARE NOW READY TO PLAY!

Made In China
Franklin Sports Inc.
Stoughton, MA 02072

Franklin ITEM#: **24868S74**

Franklin®



CHEVROLET

FLEXPRO™ NET

ITEM NUMBER: **24868S74**



NOTE: PRINT FRONT TO BACK

Franklin®

CUSTOMER SERVICE COMMITMENT

Thank you for purchasing this Franklin® product! In the event that the product you've purchased has missing or damaged parts, please contact us at:

parts@franklinsports.com

or

Visit our website at: franklinsports.com/instructions

If possible, please include product part number and parts description so we can best assist you.

WE'RE HERE FOR YOU!

PLEASE DO NOT RETURN THIS PRODUCT TO THE STORE IT WAS PURCHASED FROM.



WE ARE COMMITTED TO FULFILLING ALL REPLACEMENT PART NEEDS IMMEDIATELY.

Thank you for your continued support, and welcome to the #FranklinFamily!

Franklin® ITEM#: **24868S74**

1

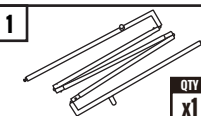
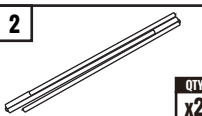
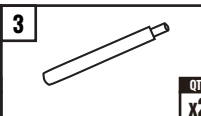
PARTS LIST

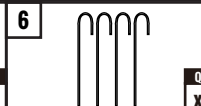
1  Pre-Corded Steel Frame Rep Part: 24868-R1	2  Pre-Corded Fiberglass Poles Rep Part: 24868-R2	3  Vertical Steel Supports Rep Part: 24868-R3	4  Net w/ Chevy Banner & Floor Rep Part: 24868-R4
5  Black Travel Bag Rep Part: 24868-R5		6  Ground Stakes Rep Part: 24804-R18	

ASSEMBLY INSTRUCTIONS

GENERAL NOTES

1. Find a clean, level place to begin the assembly of your FLEXPPO™ NET. We recommend that two adults work together to assemble this FLEXPPO™ NET.
2. Remove all components from the package and confirm all parts are included. Please see Step 1 to begin assembly.

STEP 1

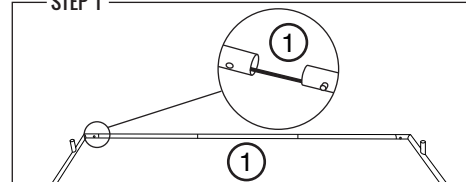

PARTS

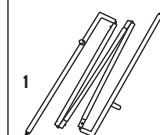

NOTE

Unfold the **Pre-Corded Steel Frame** (#1) as shown and connect all pieces together.

STEP 2

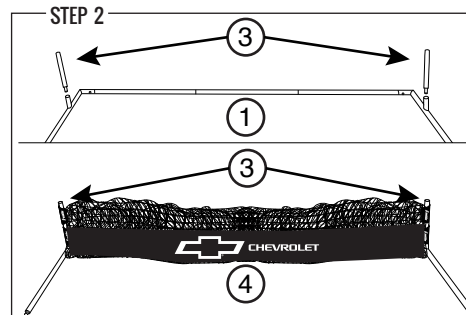

PARTS

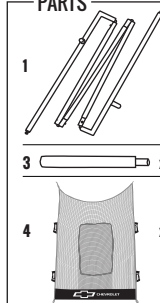

NOTE

Insert the two **Vertical Steel Support** (#3) into the **Steel Frame** (#1) as shown. Unfold the **Net** (#4) and slide the two Franklin sleeves over one **Vertical Steel Support** (#3) as shown. Then slide the two Franklin sleeves over the other **Vertical Steel Support** (#3). Note: Chevy banner must be in front for the net to be correctly set up.

STEP 3

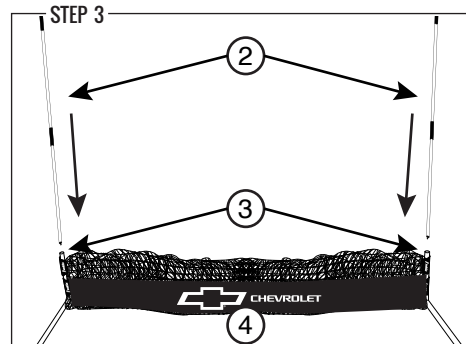

PARTS

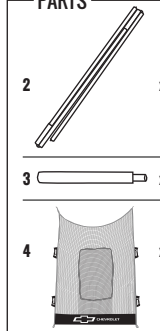

NOTE

Unfold the two **Pre-Corded Fiberglass Poles** (#2) and insert into each **Vertical Steel Support** (#3). Slide sleeves up **Fiberglass Poles** (#2) to extend **Net** (#4).

Franklin® ITEM#: **24868S74**

2