

STEP 3

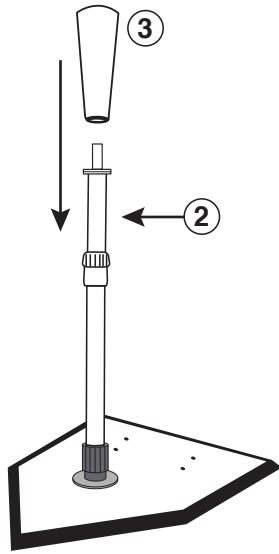

PARTS

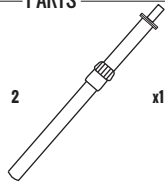

x1

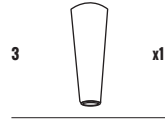

x1

NOTE

Attach **Topper (#3)** to the **Twist and Lock Post (#2)**.

STEP 4

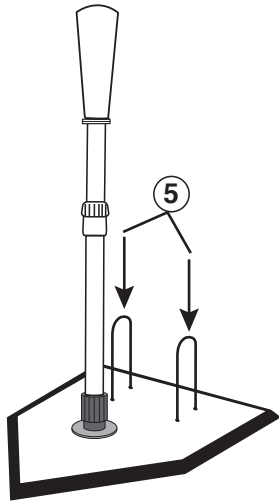

PARTS

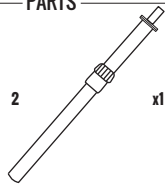

x1



x1



x2

NOTE

If outside, use **Ground Stakes (#5)** and insert (2) ground stakes into the holes on either end for added stability.

YOU ARE NOW READY TO PLAY!

Made In China
Franklin Sports Inc.
Stoughton, MA 02072



Major League Baseball trademarks and copyrights are used with permission of Major League Baseball. Visit MLB.com.



FLEX TOP[®] PRO BATTING TEE

ITEM NUMBER: **24953**



NOTE: PRINT FRONT TO BACK



CUSTOMER SERVICE COMMITMENT

Thank you for purchasing this Franklin® product! In the event that the product you've purchased has missing or damaged parts, please contact us at:

parts@franklinsports.com

or

Visit our website at: franklinsports.com/instructions

If possible, please include product part number and parts description so we can best assist you.

WE'RE HERE FOR YOU!

PLEASE DO NOT RETURN THIS PRODUCT TO THE STORE IT WAS PURCHASED FROM.

WE ARE COMMITTED TO FULFILLING ALL REPLACEMENT PART NEEDS IMMEDIATELY.

Thank you for your continued support, and welcome to the #FranklinFamily!

PARTS LIST

1	2	3	4	5
QTY x1	QTY x1	QTY x1	QTY x1	QTY x2
Base Rep. Part: 24953-R1	Twist and Lock Post Rep. Part: 24953-R2	Tee Topper Rep. Part: 24953-R3	Lock Mechanism Rep. Part: 24953-R4	Ground Stakes Rep. Part: 24954-R4

GENERAL NOTES

Remove all parts from the display box to ensure that you have all of the parts listed.

ASSEMBLY INSTRUCTIONS

STEP 1

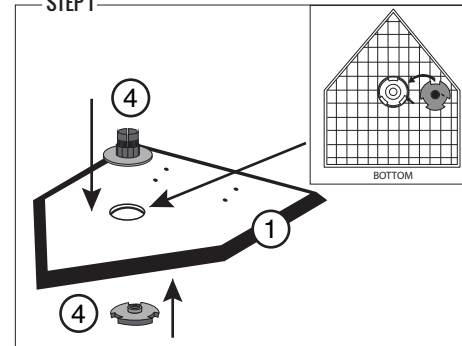

PARTS

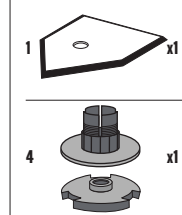

NOTE

Insert bottom piece of **Lock Mechanism (#4)** into the bottom of the **Base (#1)**. Then, place top of **Lock Mechanism (#4)** into the top of the **Base (#1)**.

STEP 2

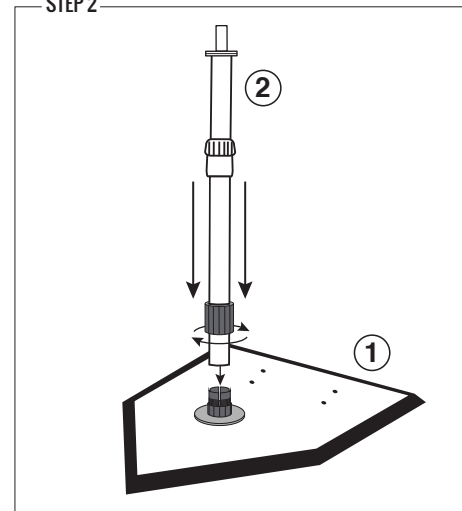

PARTS

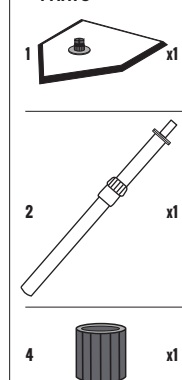

NOTE

Attach **Twist and Lock Post (#2)** to the **Base (#1)** using the screwable cap of the **Lock Mechanism (#4)**.