

# Franklin<sup>®</sup>

AGES 8+

## QUIKSET<sup>®</sup>

# TABLE TENNIS

ITEM NUMBER: **54089**

Please visit  
[www.franklinsports.com/54089](http://www.franklinsports.com/54089)  
for instructional video

For all your replacement part needs, please visit:  
[www.franklinsports.com/54089](http://www.franklinsports.com/54089)













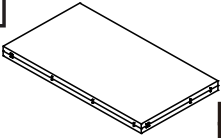
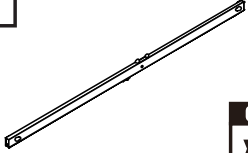

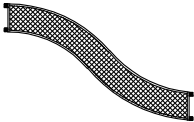
**CAUTION:**  
Adult assembly required.

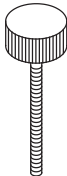

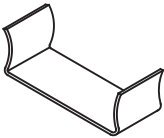
**WARNING:**  
CHOKING HAZARD--Small parts.  
Not for children under 3 yrs.

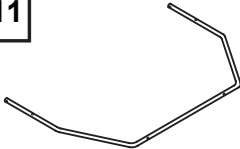
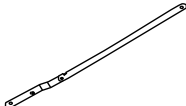
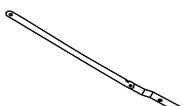
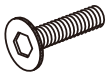
Made In China  
Franklin Sports Inc.  
Stoughton, MA 02072

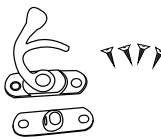
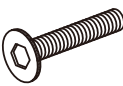
# PARTS LIST

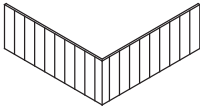
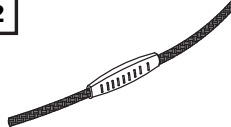
<p><b>1</b></p>  <p>QTY <b>x2</b></p> <p>Table Top Halves</p> <p>Rep. Part: 54089-R1</p>	<p><b>2</b></p>  <p>QTY <b>x4</b></p> <p>Support Bars</p> <p>Rep. Part: 54089-R2</p>	<p><b>3</b></p>  <p>QTY <b>x2</b></p> <p>Metal Posts</p> <p>Rep. Part: 54089-R3</p>	<p><b>4</b></p>  <p>QTY <b>x8</b></p> <p>Leg Levelers</p> <p>Rep. Part: 54089-R4</p>
<p><b>5</b></p>  <p>QTY <b>x1</b></p> <p>Net</p> <p>Rep. Part: 54089-R5</p>	<p><b>6</b></p>  <p>QTY <b>x 4</b></p> <p>Nut</p> <p>Rep. Part: 54089-R6</p>	<p><b>7</b></p>  <p>QTY <b>x4</b></p> <p>6mm x 45mm Bolts</p> <p>Rep. Part: 54089-R7</p>	<p><b>8</b></p>  <p>QTY <b>x8</b></p> <p>6mm x 25mm Bolts</p> <p>Rep. Part: 54089-R8</p>
<p><b>9</b></p>  <p>QTY <b>x4</b></p> <p>Metal Washers</p> <p>Rep. Part: 54089-R9</p>	<p><b>10</b></p>  <p>QTY <b>x4</b></p> <p>plastic clips</p> <p>Rep. Part: 54089-R10</p>	<p><b>23</b></p>  <p>QTY <b>x8</b></p> <p>Leg Leveler Cap</p> <p>Rep. Part: 54089-R23</p>	
<b>PRE-INSTALLED</b>			
<p><b>11</b></p>  <p>QTY <b>x 4</b></p> <p>Metal U-Legs</p> <p>Rep. Part: 54089-R11</p>	<p><b>12</b></p>  <p>QTY <b>x4</b></p> <p>Left Folding Hinges</p> <p>Rep. Part: 54089-R12</p>	<p><b>13</b></p>  <p>QTY <b>x4</b></p> <p>Right Folding Hinges</p> <p>Rep. Part: 54089-R13</p>	<p><b>14</b></p>  <p>QTY <b>x 8</b></p> <p>6mm Bolts</p> <p>Rep. Part: 54089-R14</p>
<p><b>15</b></p>  <p>QTY <b>x16</b></p> <p>Locking Nuts</p> <p>Rep. Part: 54089-R15</p>	<p><b>16</b></p>  <p>QTY <b>x40</b></p> <p>Metal Washers</p> <p>Rep. Part: 54089-R16</p>	<p><b>17</b></p>  <p>QTY <b>x2</b></p> <p>Metal Latch Set</p> <p>Rep. Part: 54089-R17</p>	<p><b>18</b></p>  <p>QTY <b>x 8</b></p> <p>6mm Bolts</p> <p>Rep. Part: 54089-R18</p>
<p><b>19</b></p>  <p>QTY <b>x 8</b></p> <p>6mm Bolts</p> <p>Rep. Part: 54089-R19</p>	<p><b>20</b></p>  <p>QTY <b>x 8</b></p> <p>Plastic Tubes</p> <p>Rep. Part: 54089-R20</p>	<p><b>21</b></p>  <p>QTY <b>x 8</b></p> <p>Corner Cap</p> <p>Rep. Part: 54089-R21</p>	<p><b>22</b></p>  <p>QTY <b>x 4</b></p> <p>Carrying Strap</p> <p>Rep. Part: 54089-R22</p>

# ASSEMBLY INSTRUCTIONS

## GENERAL NOTE

1. Find a clean, level place to begin the assembly of your Table Tennis Table. We recommend that two adults work together to assemble this Table Tennis Table.
2. Remove all the parts from the box and verify that you have all of the listed parts as shown on the parts list page. Carefully cut or tear the four corners of the box so that the bottom of the box can be used as your work surface.

## STEP 1

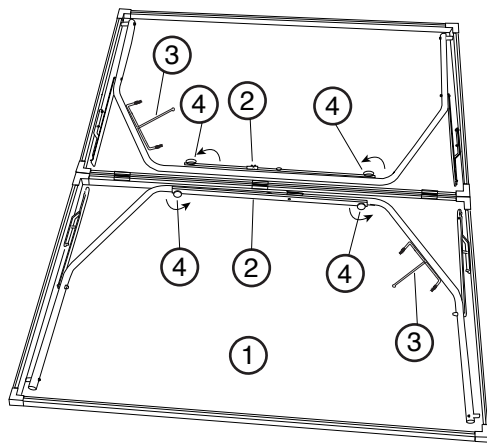

## PARTS

1		x2
2		x4
3		x2
4		x8

## NOTE

Open the two **Table Halves** (#1) as shown.

Unscrew the 4 **Leg Levelers** (#4) to retrieve the two **Support Bars** (#2).

Remove the **Metal Posts** (#3) and set it aside for later assembly.

## STEP 2

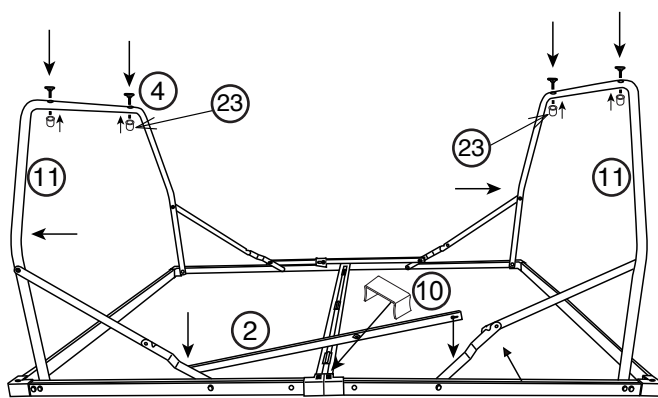

## PARTS

2		x4
4		x8
10		x4
11		x4
23		x8

## NOTE

Open the **Metal U-Legs** (#11) as shown and attach the 4 **Leg Levelers** (#4).

Attach the **Support Bars** (#2) to the leg folding hinge as shown.

Attach **Plastic Clips** (#10) as shown.

Attach **Leg Leveler Caps** (#23) as shown.

## NOTE

Push up hinge to align the support bar to lock in.



**CAUTION:**  
PINCH HAZARD! KEEP HANDS CLEAR.

**STEP 3**

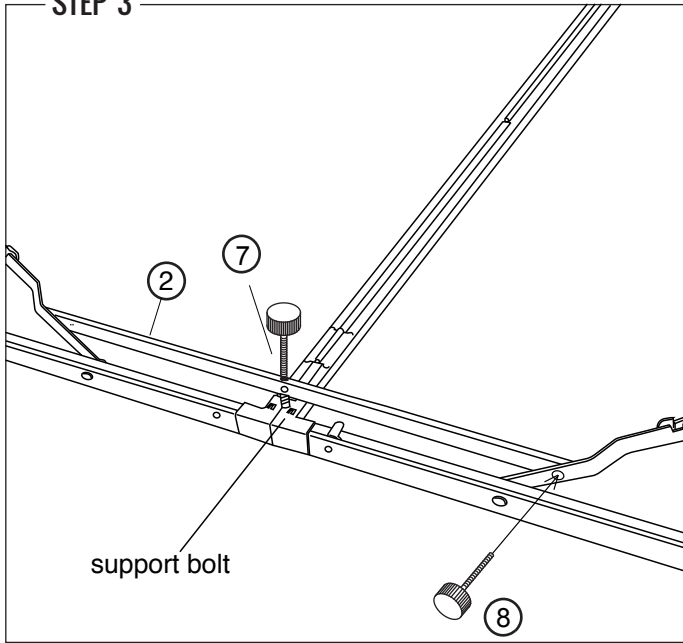

**PARTS**

2		x4
7		x4
8		x8

**NOTE**

Adjust the **Support Bolt (#7)** downward so the head of the bolt touches the frame.  
Remarks: make sure this process is done on a flat surface.

Lock in **Support Bars (#2)** using two **6mm Bolts (#8)**.

Repeat the **Support Bar (#2)** assembly on both sides as well as the other half of the table.

Assembly is completed and you can now turn table halves over.

**STEP 4**

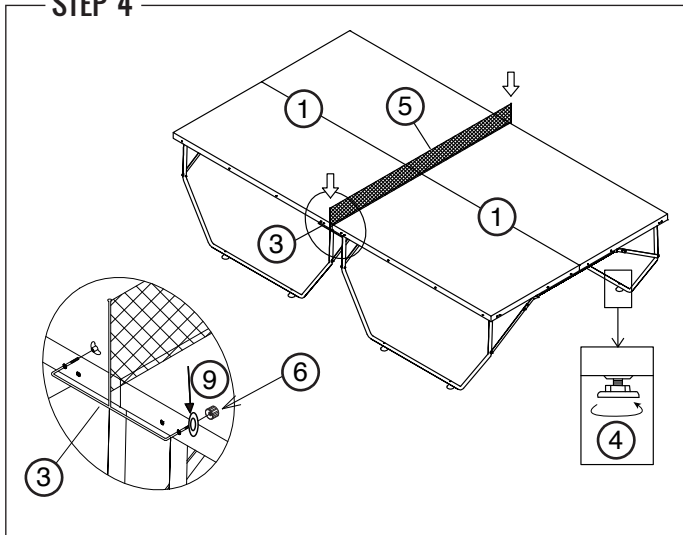

**PARTS**

1		x2
3		x2
4		x8
5		x1
6		x4
9		x4

**NOTE**

Flip the **Table Tops (#1)** and push together. Adjust the **Leg Levelers (#4)** until entire table is level. Insert **Metal Posts (#3)** into side holes and secure with **Washers (#9)** and **Nuts (#6)**. Slide **Net (#5)** over the posts.

**YOU ARE NOW READY TO PLAY!**