

STEP 7

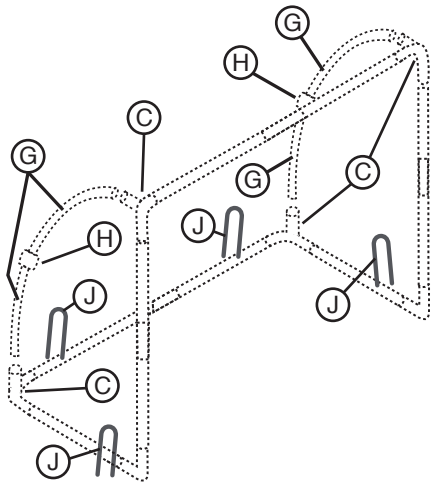

NOTE

Take the **Yellow Support Tubes (G)** & **Small Yellow Spacer Joint (H)** which you have previously assembled in Step 2. From the inside of the net, insert each support tube into the top and bottom **Corner Joints (C)** to complete the assembly of the goal. Secure the goal by adding the **Ground Stakes (J)** if desired. Your finished goal should match what you see on the front cover of this instruction manual.

PARTS

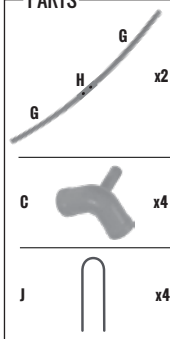

STORAGE



PARTS

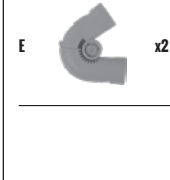

NOTE

To store flat, remove the **Yellow Tubes (G)** and press the buttons on **Folding Joints (E)** and fold the goal down.

**YOU ARE NOW READY TO PLAY!**

Made In China  
Franklin Sports Inc.  
Stoughton, MA 02072



For replacement parts:  
Visit: [www.franklinsports.com/60045X](http://www.franklinsports.com/60045X)  
Email: [parts@franklinsports.com](mailto:parts@franklinsports.com)  
Call: 1-800-225-8649

**Franklin®**

**BLACKHAWK® INSTA-SET®**  
**SOCCER GOAL**

ITEM NUMBER: **60045X**

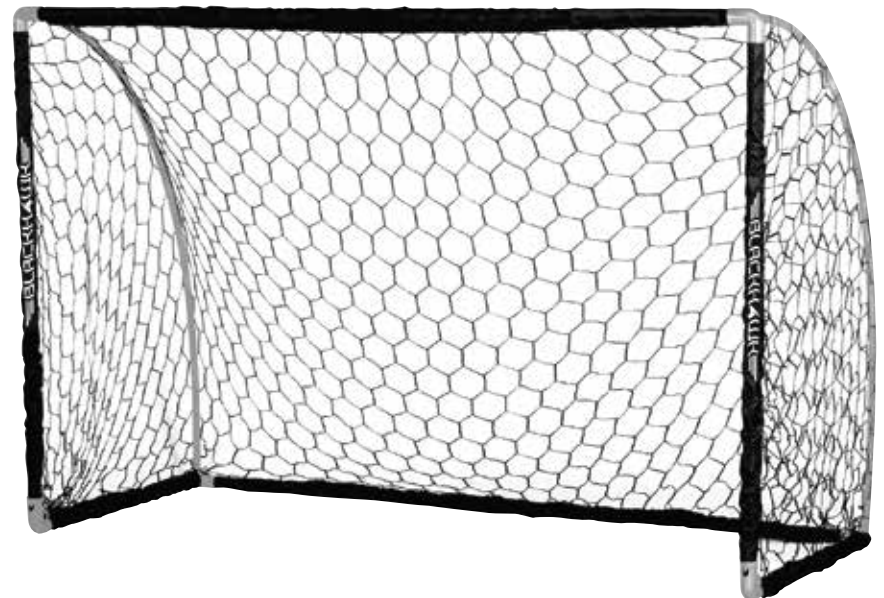

NOTE: PRINT FRONT TO BACK



## CUSTOMER SERVICE COMMITMENT

Thank you for purchasing this Franklin® product! In the event that the product you've purchased has missing or damaged parts, please contact us at:

[parts@franklinsports.com](mailto:parts@franklinsports.com)

or

Visit our website at: [www.franklinsports.com/60045X](http://www.franklinsports.com/60045X)

If possible, please include product part number and parts description so we can best assist you.









# WE'RE HERE FOR YOU!

**PLEASE DO NOT RETURN THIS PRODUCT TO THE STORE IT WAS PURCHASED FROM.**

**WE ARE COMMITTED TO FULFILLING ALL REPLACEMENT PART NEEDS IMMEDIATELY.**

Thank you for your continued support, and welcome to the #FranklinFamily!

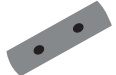
## PARTS LIST

<p><b>A</b></p>  <p>QTY <b>x4</b></p> <p>Medium Black Tubes Rep. Part: 60045-R7</p>	<p><b>B</b></p>  <p>QTY <b>x2</b></p> <p>Large Yellow Spacer Joint Rep. Part: 60045-R1</p>	<p><b>C</b></p>  <p>QTY <b>x4</b></p> <p>Corner Joint Rep. Part: 60045-R2</p>
<p><b>D</b></p>  <p>QTY <b>x2</b></p> <p>Large Black Tubes Rep. Part: 60045-R8</p>	<p><b>E</b></p>  <p>QTY <b>x2</b></p> <p>Folding Joint Rep. Part: 60045-R3</p>	<p><b>F</b></p>  <p>QTY <b>x2</b></p> <p>Small Black Tubes Rep. Part: 60045-R9</p>
<p><b>G</b></p>  <p>QTY <b>x4</b></p> <p>Yellow Support Tubes Rep. Part: 60045-R12</p>	<p><b>H</b></p>  <p>QTY <b>x2</b></p> <p>Small Yellow Spacer Joint Rep. Part: 60045-R6</p>	<p><b>I</b></p>  <p>QTY <b>x1</b></p> <p>Sleeve Net Rep. Part: 60045-R10</p>
<p><b>J</b></p>  <p>QTY <b>x4</b></p> <p>Ground Stakes Rep. Part: 60045-R11</p>		

# GENERAL NOTES

## GENERAL NOTE

Remove all components from packaging.

Sort all components using the parts list and confirm that all parts are included.

When connecting tubing to corner joints, make sure that the tubes are connected securely for the best assembly. Do this by aligning the snap lock with the holes in the corner joints, and finish by clicking the snap lock in place.

## SETUP

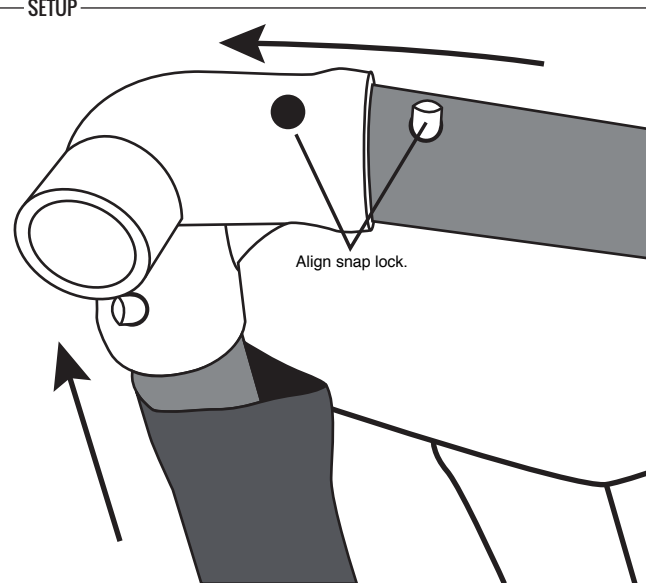

## GENERAL NOTE

Please reference the frame assembly here when putting the goal together.

**IMPORTANT:** The netting should be added during the frame assembly as noted in the instructions on the next page.

## SETUP

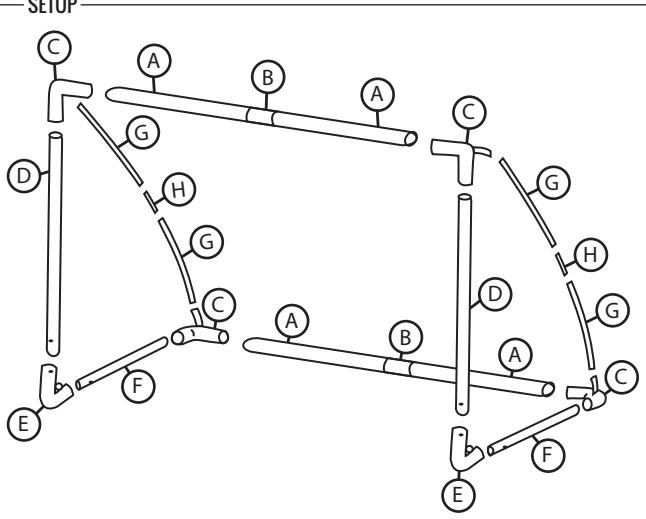

# ASSEMBLY INSTRUCTIONS

## STEP 1

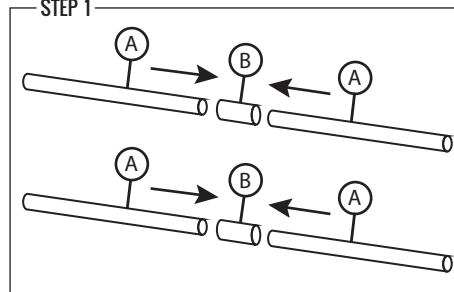

## PARTS

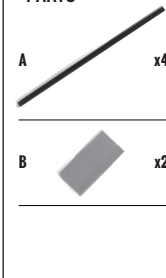

## NOTE

Assemble **Medium Black Tubes (A)** and **Large Yellow Spacer Joints (B)** as shown.

## STEP 2

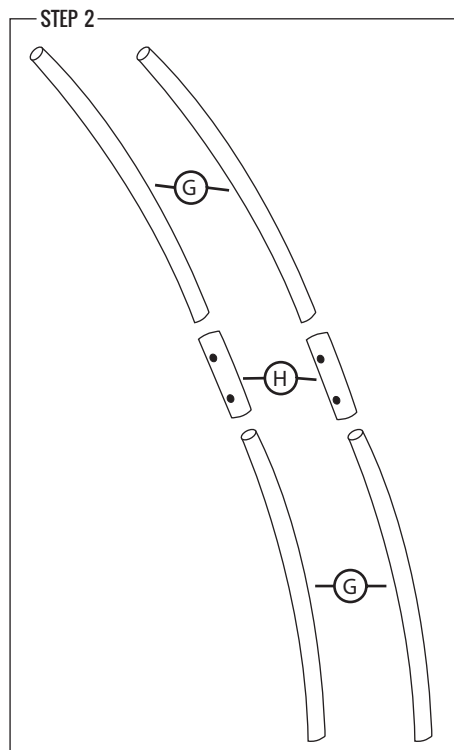

## PARTS

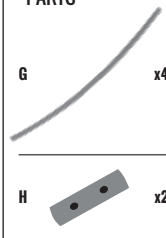

## NOTE

Assemble **Yellow Support Tubes (G)** and **Small Yellow Spacer Joints (H)** as shown. The **Yellow Support Tubes (G)** are pre-bent to help in creating the correct arc shape. The **Small Yellow Spacer Joints (H)** are also pre-bent, so do your best to align the tubing and spacer joints in one smooth arc, so that the finished connection looks more like a "C" instead of an "S". (FYI: If your connection looks more like an "S" once assembled, it is not an issue! The parts will still work correctly, the finished product just looks better when in the correct arc shape.)

STEP 3

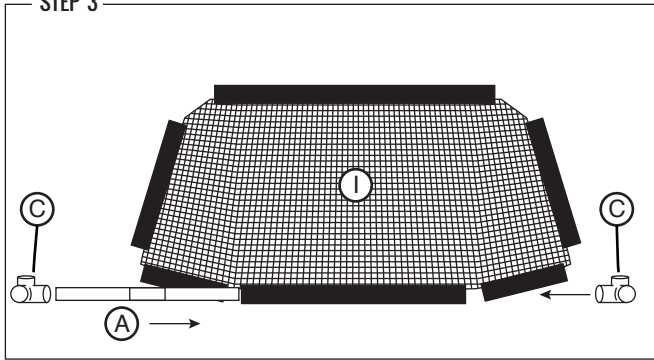

PARTS

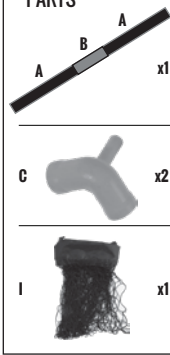

NOTE

Attach one side of **Medium Black Tube (A)** to **Corner Joint (C)**. Before attaching the other corner joint, lay the **Sleeve Net (I)** out flat and slide the tubing through the back sleeve. Once this is done, attach the other end of the **Medium Black Tube (A)** to **Corner Joint (C)**.

STEP 4

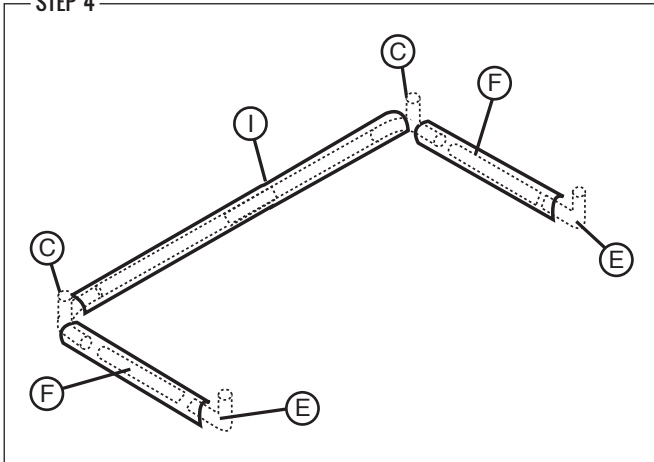

PARTS

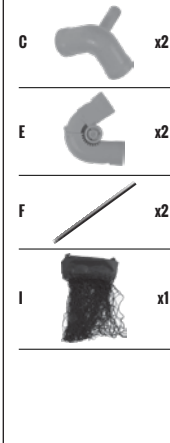

NOTE

Slide **Small Black Tubes (F)** through the bottom sleeves of the **Sleeve Net (I)** and attach to the **Corner Joints (C)** as shown. Finish by attaching the **Folding Joints (E)** to the other end of the **Small Black Tubes (F)**.

STEP 5

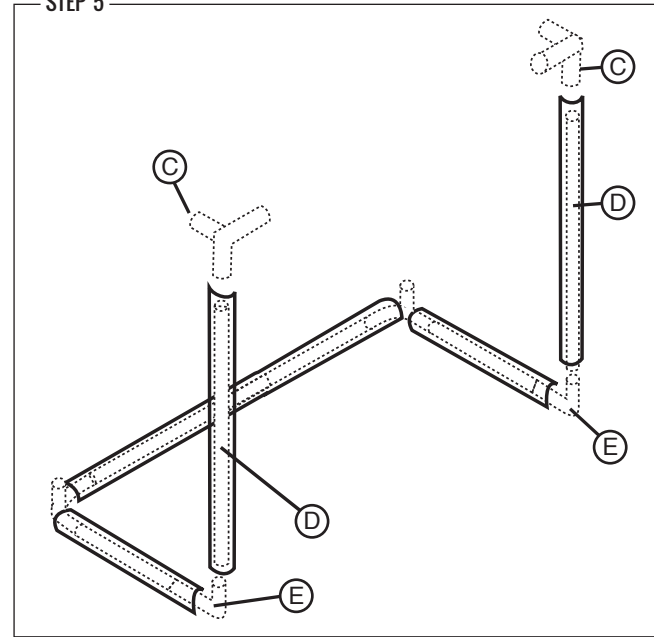

PARTS

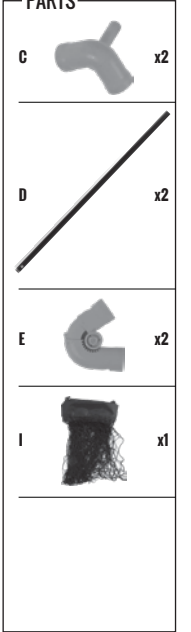

NOTE

Slide **Large Black Tubes (D)** through the **Sleeve Net (I)** and attach to the **Folding Joints (E)** as shown. Finish by attaching the **Corner Joints (C)** to the tops of the **Large Black Tubes (D)**.

STEP 6

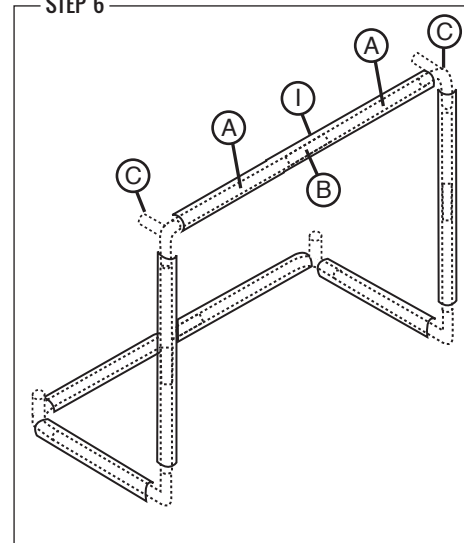

NOTE

Slide the **Medium Black Tubes (A)** & **Yellow Spacer Joint (B)** which you have previously assembled in Step 1 through the top of the **Sleeve Net (I)** and attach to **Corner Joints (C)** as shown.

PARTS

