

STEP 3

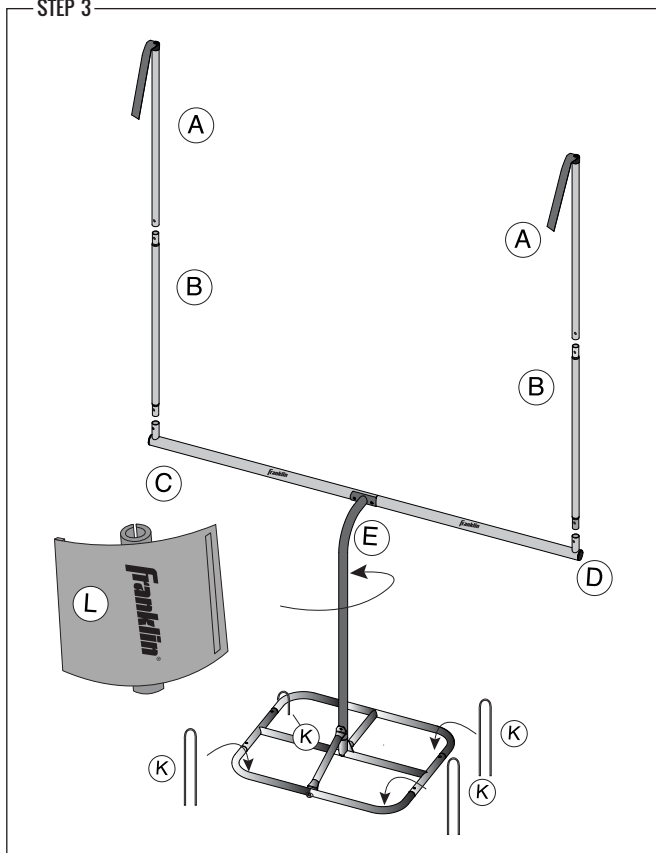

PARTS



A x2



B x2

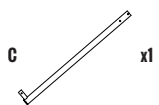

C x1



D x1

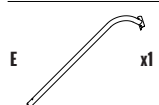

E x1

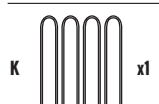

K x1



L x1

NOTE

Assemble Up rights

Connect [2] Part "A" & "B" together as shown and insert into Parts "C" and "D"

Wrap foam part "L" around Part "E" as shown.

Use the [4] ground stakes Part "K" to secure to the ground.

**YOU ARE NOW READY TO
KICK FOR THE EXTRA POINT!**

Made In China
Franklin Sports Inc.
Stoughton, MA 02072



For replacement parts:
Visit: www.franklinsports.com/92001X
Email: parts@franklinsports.com
Call: 1-800-225-8649

Franklin[®]





**STEEL
FIELD GOAL POST**

ITEM NUMBER: **92001** **92001X**

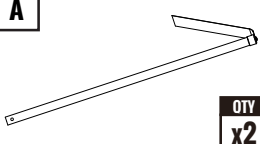
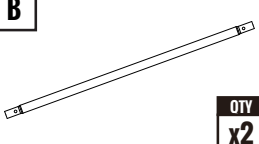
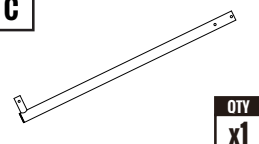
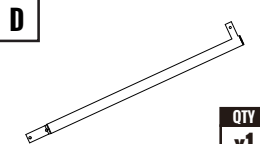
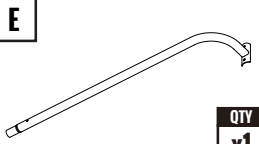

NOTE: PRINT FRONT TO BACK

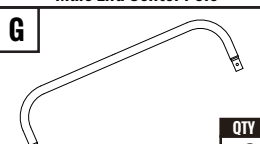
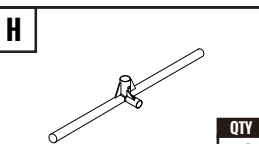
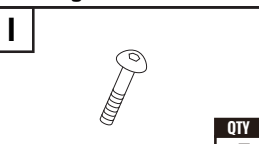
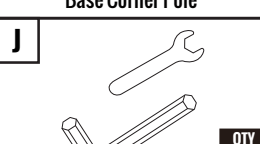
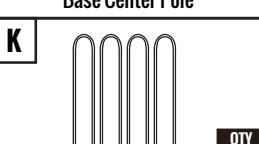
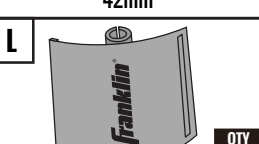
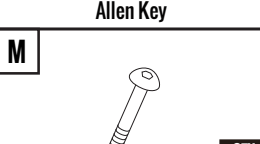
PARTS LIST

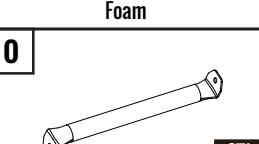
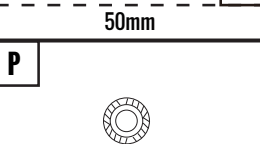
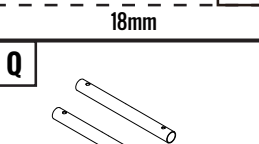
A  Pole with Flag QTY x2	B  Double Male End Center Pole QTY x2	C  Female End Corner Pole QTY x1
D  Male End Center Pole QTY x1	E  Neck Pole QTY x1	F  Single Male End Pole QTY x1
G  Base Corner Pole QTY x2	H  Base Center Pole QTY x1	I  42mm QTY x5
J  Allen Key QTY x1	K  "U" Ground Stakes QTY x1	L  Foam QTY x1
M  50mm QTY x2	N  18mm QTY x1	O  Single Male End Pole QTY x1
P  QTY x4	Q  Side Poles QTY x1	

ASSEMBLY INSTRUCTIONS

GENERAL NOTES

Remove all components from package and confirm all parts are included as shown in the parts list.



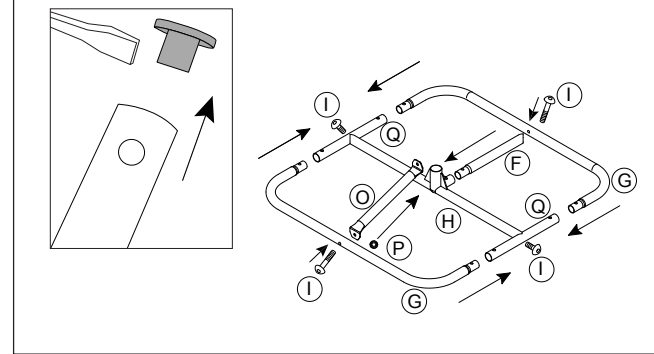





STEP 1



NOTE

Insert [1] Part "F" into Part "H" as shown
Use [2] screws Part "I" to secure Part "Q" to Part "H"
Insert [2] Part "G" as shown
Use [1] screw Part "I" to secure Part "G" to "F"
Assemble Part "O" to Part "G"
Use [1] screw Part "I" and "P" to secure Part "O" to "G"

PARTS

F 	x1
G 	x2
H 	x1
I 	x4
J 	x1
O 	x1
P 	x1
Q 	x1



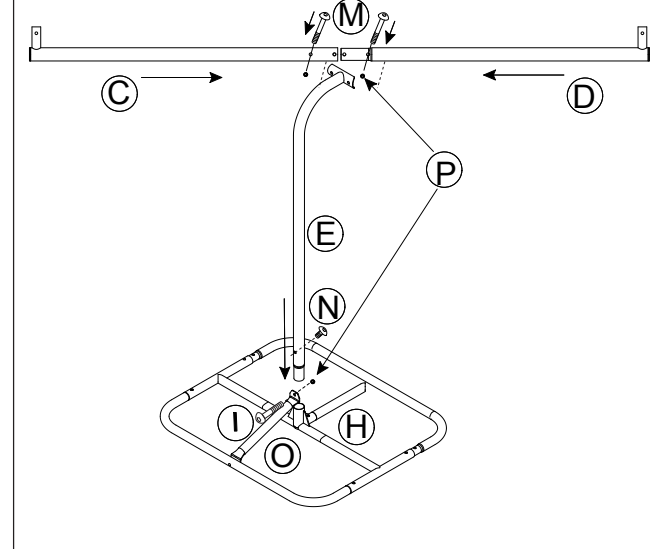



STEP 2



NOTE

Assemble Horizontal bar and post
Insert Part "E" as shown into the base
Use [1] screw Part "I" and "P" to secure Part "O" to "E"
Use [1] screw Part "N" to secure Part "E" and "H"
Connect Part "C" to Part "D" as shown
Use [2] screws Part "M" and "P" to secure Part "C" and "D" to "E"

PARTS

C 	x1
D 	x1
E 	x1
I 	x1
M 	x2
N 	x1
P 	x3